

SPECIALLY DESIGNED FOR OVERHEAD CRANES

STEEL TRACK FESTOON SYSTEM KITS

Install a high speed, smooth operating festoon system on an overhead crane or similar application. Kits include all required parts; track and trolleys, mounting clamps, cross support arms, even electrical cable which has been pre-installed on the trolleys. To install, clamp cross arms to beam or other support, affix track to support beams, roll trolleys into track and make electrical connections on each end. It's that simple. It's that fool-proof. Kits also available without cross arms and with spark resistant trolleys. Refer to model charts on following pages for system lengths and cables available.

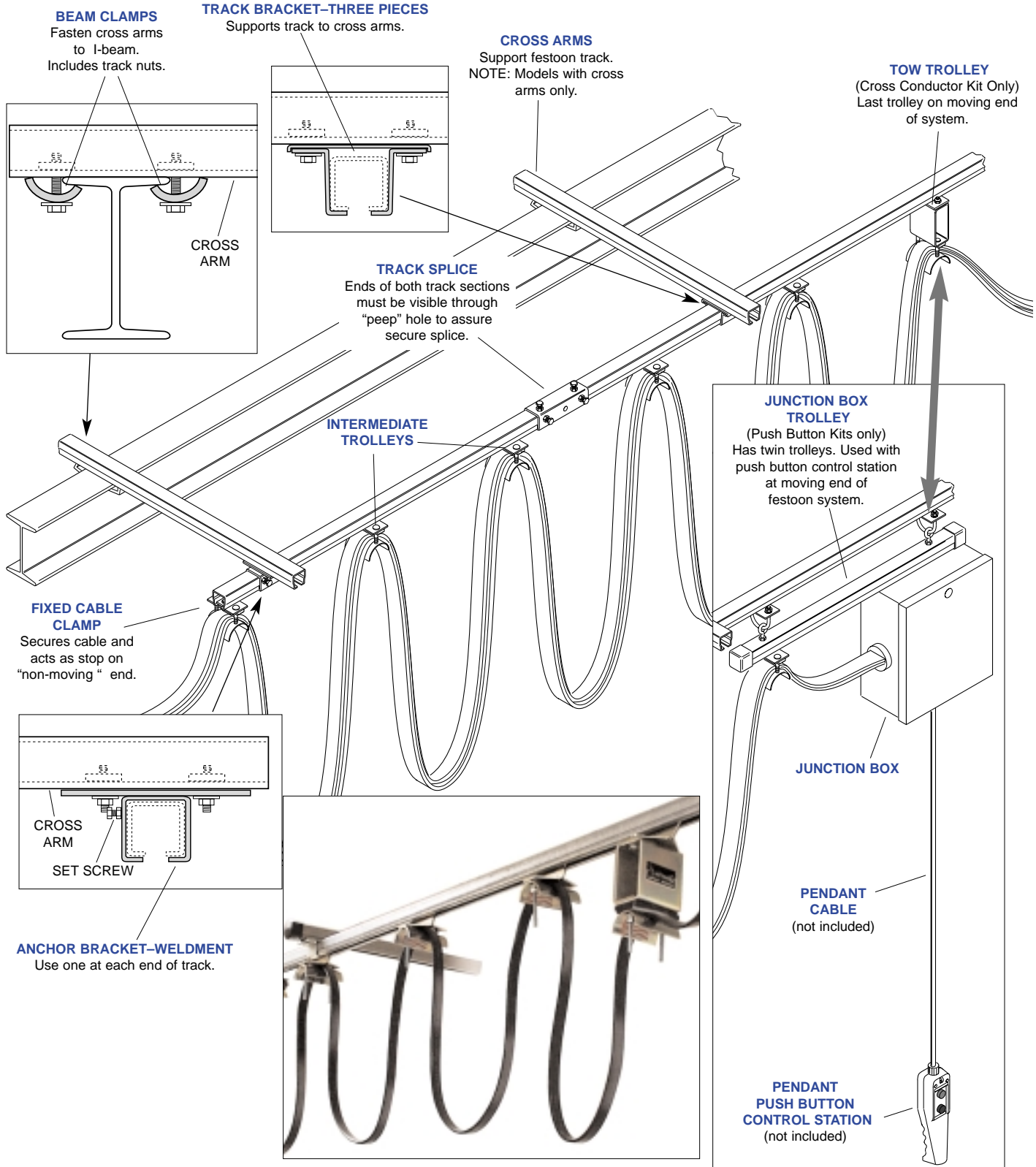



14 Gauge Track Festooned Push Button (less pendant)
16 Conductor Flat Cables (#16-8C & #16-8C)

CRANE SPAN	10'	20'	30'	40'	50'	60'	70'	80'	90'	100'
W/cross arms	HNA13141	HNA14241	HNA14341	HNA14441	HNA14541	HNA14641	HNA14741	HNA14841	HNA14941	HNA15041
W/O cross arms*	HNA13142	HNA14242	HNA14342	HNA14442	HNA14542	HNA14642	HNA14742	HNA14842	HNA14942	HNA15042
Spark resistant**, W/cross arms	HNA21141	HNA21241	HNA21341	HNA21441	HNA21541	HNA21641	HNA21741	HNA21841	HNA21941	HNA22041
Spark Resistant**, W/O crossarms*	HNA21142	HNA21242	HNA21342	HNA21442	HNA21542	HNA21642	HNA21742	HNA21842	HNA21942	HNA22042

SYSTEM INCLUDES:

Roller Track (10 foot sections)	1	2	3	4	5	6	7	8	9	10
Track Splice	0	1	2	3	4	5	6	7	8	9
Track Bracket*	0	2	4	6	8	10	12	14	16	18
Anchor Bracket*	2	2	2	2	2	2	2	2	2	2
Cross Arms (30")*	2	4	6	8	10	12	14	16	18	20
Locking Beam Clamp	4	8	12	16	20	24	28	32	36	40
End Stop	1	1	1	1	1	1	1	1	1	1
Fixed Cable Clamp	1	1	1	1	1	1	1	1	1	1
Control Trolley	1	1	1	1	1	1	1	1	1	1
Intermediate Trolley	2	3	5	6	8	10	12	14	16	18
Control Cable #16-8c (length = system + hook-up)	2	2	2	2	2	2	2	2	2	2
Flat Cable Connector	2	2	2	2	2	2	2	2	2	2
Junction Box Assembly	1	1	1	1	1	1	1	1	1	1

14 Gauge Track Cross Conductors

12 Conductor Flat Cables (#14-4C & #16-8C)

CRANE SPAN	10'	20'	30'	40'	50'	60'	70'	80'	90'	100'
W/cross arms	HNA15141	HNA15241	HNA15341	HNA15441	HNA15541	HNA15641	HNA15741	HNA15841	HNA15941	HNA13441
W/O cross arms*	HNA15142	HNA15242	HNA15342	HNA15442	HNA15542	HNA15642	HNA15742	HNA15842	HNA15942	HNA13442
Spark resistant**, W/cross arms	HNA22141	HNA22241	HNA22341	HNA22441	HNA22541	HNA22641	HNA22741	HNA22841	HNA22941	HNA23041
Spark Resistant**, W/O crossarms*	HNA22142	HNA22242	HNA22342	HNA22442	HNA22542	HNA22642	HNA22742	HNA22842	HNA22942	HNA23042

SYSTEM INCLUDES:

Roller Track (10 foot sections)	1	2	3	4	5	6	7	8	9	10
Track Splice	0	1	2	3	4	5	6	7	8	9
Track Bracket*	0	2	4	6	8	10	12	14	16	18
Anchor Bracket*	2	2	2	2	2	2	2	2	2	2
Cross Arms (30")*	2	4	6	8	10	12	14	16	18	20
Locking Beam Clamp	4	8	12	16	20	24	28	32	36	40
End Stop	1	1	1	1	1	1	1	1	1	1
Fixed Cable Clamp	1	1	1	1	1	1	1	1	1	1
Tow Trolley	1	1	1	1	1	1	1	1	1	1
Intermediate Trolley	2	3	5	6	8	10	12	14	16	18
Power Cable #14-4C (length = system + hook-up)	1	1	1	1	1	1	1	1	1	1
Control Cable #16-8c (length = system + hook-up)	1	1	1	1	1	1	1	1	1	1
Flat Cable Connector	2	2	2	2	2	2	2	2	2	2

14 Gauge Track Cross Conductors

12 Conductor Flat Cables (#12-4C & #16-8C)

CRANE SPAN	10'	20'	30'	40'	50'	60'	70'	80'	90'	100'
W/cross arms	HNA18141	HNA18241	HNA18341	HNA18441	HNA18541	HNA18641	HNA18741	HNA18841	HNA18941	HNA19041
W/O cross arms*	HNA18142	HNA18242	HNA18342	HNA18442	HNA18542	HNA18642	HNA18742	HNA18842	HNA18942	HNA19042
Spark resistant**, W/cross arms	HNA23141	HNA23241	HNA23341	HNA23441	HNA23541	HNA23641	HNA23741	HNA23841	HNA23941	HNA24041
Spark Resistant**, W/O crossarms*	HNA23142	HNA23242	HNA23342	HNA23442	HNA23542	HNA23642	HNA23742	HNA23842	HNA23942	HNA24042

SYSTEM INCLUDES:

Roller Track (10 foot sections)	1	2	3	4	5	6	7	8	9	10
Track Splice	0	1	2	3	4	5	6	7	8	9
Track Bracket*	0	2	4	6	8	10	12	14	16	18
Anchor Bracket*	2	2	2	2	2	2	2	2	2	2
Cross Arms (30")*	2	4	6	8	10	12	14	16	18	20
Locking Beam Clamp	4	8	12	16	20	24	28	32	36	40
End Stop	1	1	1	1	1	1	1	1	1	1
Fixed Cable Clamp	1	1	1	1	1	1	1	1	1	1
Tow Trolley	1	1	1	1	1	1	1	1	1	1
Intermediate Trolley	2	3	5	6	8	10	12	14	16	18
Power Cable #12-4C (length = system + hook-up)	1	1	1	1	1	1	1	1	1	1
Control Cable #16-8c (length = system + hook-up)	1	1	1	1	1	1	1	1	1	1
Flat Cable Connector	4	4	4	4	4	4	4	4	4	4

* Cross arms, track brackets and anchor brackets not included. ** Spark resistant systems may be identified by brass wheels on trolleys.

14 Gauge Track Cross Conductors

12 Conductor Flat Cables (#10-4C & #16-8C)

CRANE SPAN	10'	20'	30'	40'	50'	60'	70'	80'	90'	100'
W/cross arms	HNA19141	HNA19241	HNA19341	HNA19441	HNA19541	HNA19641	HNA19741	HNA19841	HNA19941	HNA20041
W/O cross arms*	HNA19142	HNA19242	HNA19342	HNA19442	HNA19542	HNA19642	HNA19742	HNA19842	HNA19942	HNA20042
Spark resistant**, W/cross arms	HNA24141	HNA24241	HNA24341	HNA24441	HNA24541	HNA24641	HNA24741	HNA24841	HNA24941	HNA25041
Spark Resistant**, W/O crossarms*	HNA24142	HNA24242	HNA24342	HNA24442	HNA24542	HNA24642	HNA24742	HNA24842	HNA24942	HNA25042

SYSTEM INCLUDES:

Roller Track (10 foot sections)	1	2	3	4	5	6	7	8	9	10
Track Splice	0	1	2	3	4	5	6	7	8	9
Track Bracket*	0	2	4	6	8	10	12	14	16	18
Anchor Bracket*	2	2	2	2	2	2	2	2	2	2
Cross Arms (30")*	2	4	6	8	10	12	14	16	18	20
Locking Beam Clamp	4	8	12	16	20	24	28	32	36	40
End Stop	1	1	1	1	1	1	1	1	1	1
Fixed Cable Clamp	1	1	1	1	1	1	1	1	1	1
Tow Trolley	1	1	1	1	1	1	1	1	1	1
Intermediate Trolley	2	3	5	6	8	10	12	14	16	18
Power Cable #10-4C (length = system + hook-up)	1	1	1	1	1	1	1	1	1	1
Control Cable #16-8c (length = system + hook-up)	1	1	1	1	1	1	1	1	1	1
Flat Cable Connector	4	4	4	4	4	4	4	4	4	4

14 Gauge Track Cross Conductors

12 Conductor Flat Cables (#8-4C & #16-8C)

CRANE SPAN	10'	20'	30'	40'	50'	60'	70'	80'	90'	100'
W/cross arms	HNA20141	HNA20241	HNA20341	HNA20441	HNA20541	HNA20641	HNA20741	HNA20841	HNA20941	HNA21041
W/O cross arms*	HNA20142	HNA20242	HNA20342	HNA20442	HNA20542	HNA20642	HNA20742	HNA20842	HNA20942	HNA21042
Spark resistant**, W/cross arms	HNA25141	HNA25241	HNA25341	HNA25441	HNA25541	HNA25641	HNA25741	HNA25841	HNA25941	HNA26041
Spark Resistant**, W/O crossarms*	HNA25142	HNA25242	HNA25342	HNA25442	HNA25542	HNA25642	HNA25742	HNA25842	HNA25942	HNA26042

SYSTEM INCLUDES:

Roller Track (10 foot sections)	1	2	3	4	5	6	7	8	9	10
Track Splice	0	1	2	3	4	5	6	7	8	9
Track Bracket*	0	2	4	6	8	10	12	14	16	18
Anchor Bracket*	2	2	2	2	2	2	2	2	2	2
Cross Arms (30")*	2	4	6	8	10	12	14	16	18	20
Locking Beam Clamp	4	8	12	16	20	24	28	32	36	40
End Stop	1	1	1	1	1	1	1	1	1	1
Fixed Cable Clamp	1	1	1	1	1	1	1	1	1	1
Tow Trolley	1	1	1	1	1	1	1	1	1	1
Intermediate Trolley	2	3	5	6	8	10	12	14	16	18
Power Cable #8-4C (length = system + hook-up)	1	1	1	1	1	1	1	1	1	1
Control Cable #16-8c (length = system + hook-up)	1	1	1	1	1	1	1	1	1	1
Flat Cable Connector	4	4	4	4	4	4	4	4	4	4

14 Gauge Track Cross Conductors

4 Conductor Flat Cables (#14-4C)

CRANE SPAN	10'	20'	30'	40'	50'	60'	70'	80'	90'	100'
W/cross arms	HNA15143	HNA15243	HNA15343	HNA15443	HNA15543	HNA15643	HNA15743	HNA15843	HNA15943	HNA13443
W/O cross arms*	HNA15144	HNA15244	HNA15344	HNA15444	HNA15544	HNA15644	HNA15744	HNA15844	HNA15944	HNA13444
Spark resistant**, W/cross arms	HNA22143	HNA22243	HNA22343	HNA22443	HNA22543	HNA22643	HNA22743	HNA22843	HNA22943	HNA23043
Spark Resistant**, W/O crossarms*	HNA22144	HNA22244	HNA22344	HNA22444	HNA22544	HNA22644	HNA22744	HNA22844	HNA22944	HNA23044

SYSTEM INCLUDES:

Roller Track (10 foot sections)	1	2	3	4	5	6	7	8	9	10
Track Splice	0	1	2	3	4	5	6	7	8	9
Track Bracket*	0	2	4	6	8	10	12	14	16	18
Anchor Bracket*	2	2	2	2	2	2	2	2	2	2
Cross Arms (30")*	2	4	6	8	10	12	14	16	18	20
Locking Beam Clamp	4	8	12	16	20	24	28	32	36	40
End Stop	1	1	1	1	1	1	1	1	1	1
Fixed Cable Clamp	1	1	1	1	1	1	1	1	1	1
Tow Trolley	1	1	1	1	1	1	1	1	1	1
Intermediate Trolley	2	3	5	6	8	10	12	14	16	18
Power Cable #14-4C (length = system + hook-up)	1	1	1	1	1	1	1	1	1	1
Flat Cable Connector	2	2	2	2	2	2	2	2	2	2

* Cross arms, track brackets and anchor brackets not included. ** Spark resistant systems may be identified by brass wheels on trolleys.



14 Gauge Track Cross Conductors

4 Conductor Flat Cables (#12-4C)

CRANE SPAN	10'	20'	30'	40'	50'	60'	70'	80'	90'	100'
W/cross arms	HNA18143	HNA18243	HNA18343	HNA18443	HNA18543	HNA18643	HNA18743	HNA18843	HNA18943	HNA19043
W/O cross arms*	HNA18144	HNA18244	HNA18344	HNA18444	HNA18544	HNA18644	HNA18744	HNA18844	HNA18944	HNA19044
Spark resistant**, W/cross arms	HNA23143	HNA23243	HNA23343	HNA23443	HNA23543	HNA23643	HNA23743	HNA23843	HNA23943	HNA24043
Spark Resistant**, W/O crossarms*	HNA23144	HNA23244	HNA23344	HNA23444	HNA23544	HNA23644	HNA23744	HNA23844	HNA23944	HNA24044

SYSTEM INCLUDES:

Roller Track (10 foot sections)	1	2	3	4	5	6	7	8	9	10
Track Splice	0	1	2	3	4	5	6	7	8	9
Track Bracket*	0	2	4	6	8	10	12	14	16	18
Anchor Bracket*	2	2	2	2	2	2	2	2	2	2
Cross Arms (30")*	2	4	6	8	10	12	14	16	18	20
Locking Beam Clamp	4	8	12	16	20	24	28	32	36	40
End Stop	1	1	1	1	1	1	1	1	1	1
Fixed Cable Clamp	1	1	1	1	1	1	1	1	1	1
Tow Trolley	1	1	1	1	1	1	1	1	1	1
Intermediate Trolley	2	3	5	6	8	10	12	14	16	18
Power Cable #12-4C (length = system + hook-up)	1	1	1	1	1	1	1	1	1	1
Flat Cable Connector	2	2	2	2	2	2	2	2	2	2

14 Gauge Track Cross Conductors

4 Conductor Flat Cables (#10-4C)

CRANE SPAN	10'	20'	30'	40'	50'	60'	70'	80'	90'	100'
W/cross arms	HNA19143	HNA19243	HNA19343	HNA19443	HNA19543	HNA19643	HNA19743	HNA19843	HNA19943	HNA20043
W/O cross arms*	HNA19144	HNA19244	HNA19344	HNA19444	HNA19544	HNA19644	HNA19744	HNA19844	HNA19944	HNA20044
Spark resistant**, W/cross arms	HNA24143	HNA24243	HNA24343	HNA24443	HNA24543	HNA24643	HNA24743	HNA24843	HNA24943	HNA25043
Spark Resistant**, W/O crossarms*	HNA24144	HNA24244	HNA24344	HNA24444	HNA24544	HNA24644	HNA24744	HNA24844	HNA24944	HNA25044

SYSTEM INCLUDES:

Roller Track (10 foot sections)	1	2	3	4	5	6	7	8	9	10
Track Splice	0	1	2	3	4	5	6	7	8	9
Track Bracket*	0	2	4	6	8	10	12	14	16	18
Anchor Bracket*	2	2	2	2	2	2	2	2	2	2
Cross Arms (30")*	2	4	6	8	10	12	14	16	18	20
Locking Beam Clamp	4	8	12	16	20	24	28	32	36	40
End Stop	1	1	1	1	1	1	1	1	1	1
Fixed Cable Clamp	1	1	1	1	1	1	1	1	1	1
Tow Trolley	1	1	1	1	1	1	1	1	1	1
Intermediate Trolley	2	3	5	6	8	10	12	14	16	18
Power Cable #10-4C (length = system + hook-up)	1	1	1	1	1	1	1	1	1	1
Flat Cable Connector	2	2	2	2	2	2	2	2	2	2

14 Gauge Track Cross Conductors

4 Conductor Flat Cables (#8-4C)

CRANE SPAN	10'	20'	30'	40'	50'	60'	70'	80'	90'	100'
W/cross arms	HNA20143	HNA20243	HNA20343	HNA20443	HNA20543	HNA20643	HNA20743	HNA20843	HNA20943	HNA21043
W/O cross arms*	HNA20144	HNA20244	HNA20344	HNA20444	HNA20544	HNA20644	HNA20744	HNA20844	HNA20944	HNA21044
Spark resistant**, W/cross arms	HNA25143	HNA25243	HNA25343	HNA25443	HNA25543	HNA25643	HNA25743	HNA25843	HNA25943	HNA26043
Spark Resistant**, W/O crossarms*	HNA25144	HNA25244	HNA25344	HNA25444	HNA25544	HNA25644	HNA25744	HNA25844	HNA25944	HNA26044

SYSTEM INCLUDES:

Roller Track (10 foot sections)	1	2	3	4	5	6	7	8	9	10
Track Splice	0	1	2	3	4	5	6	7	8	9
Track Bracket*	0	2	4	6	8	10	12	14	16	18
Anchor Bracket*	2	2	2	2	2	2	2	2	2	2
Cross Arms (30")*	2	4	6	8	10	12	14	16	18	20
Locking Beam Clamp	4	8	12	16	20	24	28	32	36	40
End Stop	1	1	1	1	1	1	1	1	1	1
Fixed Cable Clamp	1	1	1	1	1	1	1	1	1	1
Tow Trolley	1	1	1	1	1	1	1	1	1	1
Intermediate Trolley	2	3	5	6	8	10	12	14	16	18
Power Cable #8-4C (length = system + hook-up)	1	1	1	1	1	1	1	1	1	1
Flat Cable Connector	2	2	2	2	2	2	2	2	2	2

* Cross arms, track brackets and anchor brackets not included.
 ** Spark resistant systems may be identified by brass wheels on trolleys.

COMPONENTS – C-Rail Festoon

Series “CF” for FLAT Cable

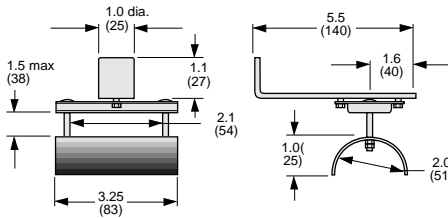

FLAT CABLE END CLAMP #C35-FE-02
Trolley Weight = 1.46 lbs

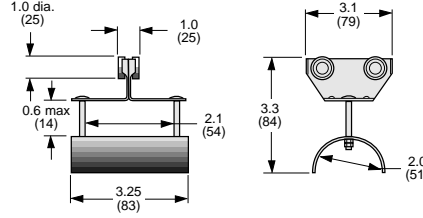

FLAT CABLE TROLLEY #C35-FC-32
Trolley Weight = 0.84 lbs

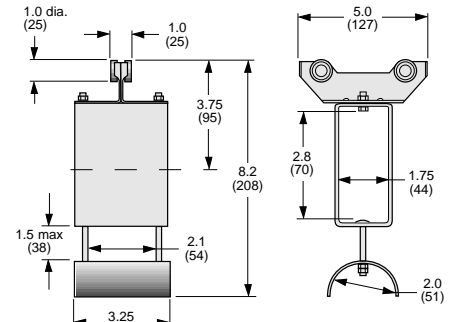

FLAT CABLE TOW TROLLEY #C35-FT-52
Trolley Weight = 2.28 lbs

Series “CR” for ROUND Cable or Hose

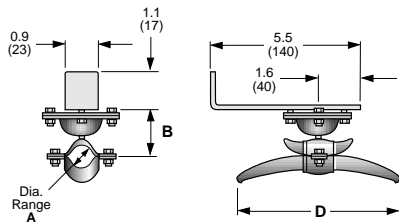

ROUND CABLE END CLIP

1 = #C35-RE-11 & 2 = #C35-RE-12

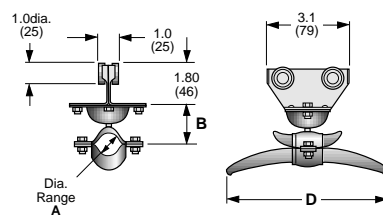

ROUND CABLE TROLLEY

1 = #C35-RC-11 & 2 = #C35-RC-12

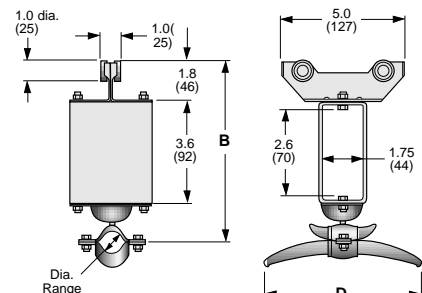

ROUND CABLE TOW TROLLEY

1 = #C35-RT-11 & 2 = #C35-RT-12

O.D. CODE*	CABLE O.D. RANGE A in. (mm)	B in. (mm)	D in. (mm)	WGT lb. (kg)
1	0.31 to 0.59 (8 - 15)	1.25 (32)	2.75 (70)	1.4 (.63)
2	0.60 to 0.94 (15 - 24)	1.4 (37)	3.9 (98)	1.5 (.69)

O.D. CODE*	CABLE O.D. RANGE A in. (mm)	B in. (mm)	D in. (mm)	WGT lb. (kg)
1	0.31 to 0.59 (8 - 15)	1.1 (32)	2.75 (70)	0.9 (.40)
2	0.60 to 0.94 (15 - 24)	1.25 (27)	3.9 (98)	1.0 (.46)

O.D. CODE*	CABLE O.D. RANGE A in. (mm)	B in. (mm)	D in. (mm)	WGT lb. (kg)
1	0.31 to 0.59 (8 - 15)	6.5 (165)	2.75 (70)	2.3 (1.05)
2	0.60 to 0.94 (15 - 24)	6.7 (170)	3.9 (98)	2.5 (1.10)

* Standard Round Kits include Trolleys & Clips with O.D. Code “2” (fits std. 3/8 in. I.D. hose).

Accessories for Flat and Round Kits

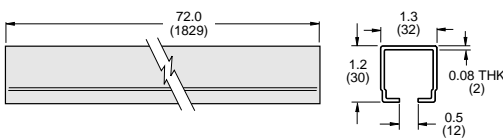

C-RAIL TRACK SECTIONS — GALVANIZED
#C35-TR-06 Weight = 6.3 lbs

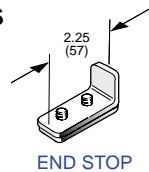

END STOP
#WS30-ES
Weight = 0.3 lbs

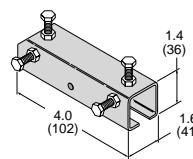

NOTCHED COUPLER/HANGER
#C35-CP-01
Weight = 1.0 lbs

COUPLER/HANGER BRACKET
#C35-CP-02
Weight = 1.25 lbs

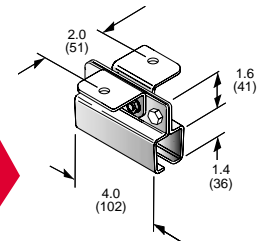

OPTIONAL Components Flat and Round Kits

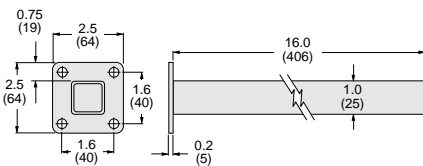

TOW ARM

Attaches to your machine and inserts into Tow Trolley to tow the system.

DESCRIPTION	WGT lb. (kg)	CATALOG NUMBER
TOW ARM	1.3 (59)	CTA-01

FLAT -TO-ROUND CABLE CONNECTOR SET



DESCRIPTION	MODEL NUMBER
Set of 2 Locking Plugs	LC-01

Go quickly and safely from flat to round cable. Consists of one each male and female plugs designed to accept flat or round cable and lock together securely. Plugs are 3-pole, 4-wire plus ground and will accommodate round cable sizes #14 AWG through #10 AWG; flat cable up to 1.00" wide. Ratings: 20 amp, 480 volt, 3 phase. NEMA configuration #L16-20. Plugs are double-insulated plastic and resist impact, corrosion and most chemicals.

MULTIPLE CABLE CONNECTOR

Aluminum cast connector provides a weather-tight connection between multiple cables (flat and/or round) and junction box. Order un-cut (blank) model and machine fiber-board stiffener and rubber insert to suit, OR order a pre-cut connector by providing cutting pattern.

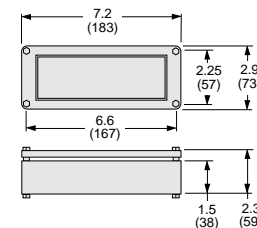

DESCRIPTION	MODEL NUMBER
Blank Connector	MCC-1U
Pre-cut Connector	MCC-1C

*Please provide cutting pattern for #MCC-1C.